

Data Sheet



Article number: 021816011360

Description: Clamp with bracket and rubber
SPGU 6011. 360/30 SK

Measures

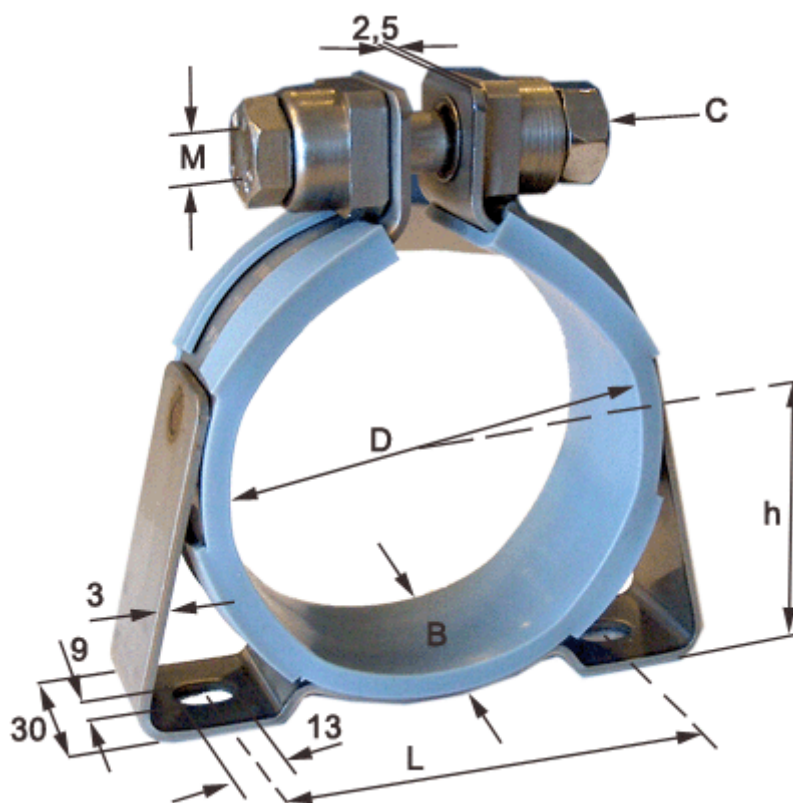

C (screw type) = SK hexagon screw

Diameter D = 360

h = 188

L = 345

Width B = 30